

CliniMix® Lead Safe™ Wall Mounted Thermostatic Progressive Basin Mixer 135-165

PRODUCT CODES:

- 100.34.71.00



TABLE OF CONTENTS

1.0	INTRODUCTION	1
2.0	SAFETY	2
3.0	DESCRIPTION	2
4.0	DIMENSIONS	2
5.0	WATER SUPPLY CONDITIONS	3
6.0	INSTALLATION	4
7.0	COMMISSIONING	7
8.0	OPERATION	9
9.0	SERVICING	10
10.0	MAINTENANCE	13
11.0	DISINFECTION	14
12.0	WARRANTY	15
13.0	TROUBLESHOOTING	16
14.0	APPENDIX	17

1.0 INTRODUCTION

The CliniMix® Lead Safe™ Wall Mounted Thermostatic Progressive Basin Mixer 135 – 165 is a high-performance thermostatic mixing valve suitable for a wide range of applications. The valve is designed to comply with 'AS4032. Thermostatic Mixing Valves - Materials, Design and Performance Requirements'. The mixing valve has the following features:

- Complies with the requirements of AS4032.4 – Thermostatic Mixing Valves.
- Provides high stability of mixed water temperature even under changing inlet conditions.
- Ensures rapid shut down of mixed outlet flow in the event of hot or cold water supply failure.
- Designed for quick and simple in-situ servicing.
- Suitable for installation into AS3500 compliant systems with hot water temperature as low as 55°Celsius.
- Fitted with tamper resistant temperature adjustment mechanism.
- Cool touch, non-conductive design in the hot side of the body, which minimises the risk of burns.
- Round smooth design to facilitate easy cleaning.
- Self-draining spout design.
- Unique hygiene flush feature for in-situ disinfection.

IMPORTANT: All GalvinCare® mental health taps are tested in accordance with AS/NZS 3718 and leave our premises in good working order. Document to be read in conjunction with CliniMix® Progressive Thermostatic Mixing Valve manual.

2.0 SAFETY

The CliniMix® Thermostatic Progressive Mixing Valve is a high-performance valve designed to give stable and dependable operation, provided it is installed, commissioned, operated and maintained as per the recommendations outlined in this manual. It should be noted however that this valve should not be considered as an alternative to adequate supervision and duty of care during its use and operation.

Note: The mixing valve, inlet controls, pipe work and the surrounding area may become hot when installed which may cause burn injuries. Precautions should be taken to ensure that these surfaces cannot cause such injuries.

3.0 DESCRIPTION

This manual covers the CliniMix® Lead Safe™ Wall Mounted Thermostatic Progressive Basin Mixer 135 – 165. These are designed to provide water from ambient cold up to a safe maximum temperature for hand washing. This mixing valve is supplied with integral isolating valves, strainers, check valves and flow regulators and is provided with a facility for thermal disinfecting of the cold inlet side and mixed water.

The hot side of the body and the inlet is insulated to ensure the body surface is maintained at a safe temperature when the mixer is in operation.

Avoid using heat for soldering near the mixer inlets to prevent damage to internal components.

4.0 DIMENSIONS

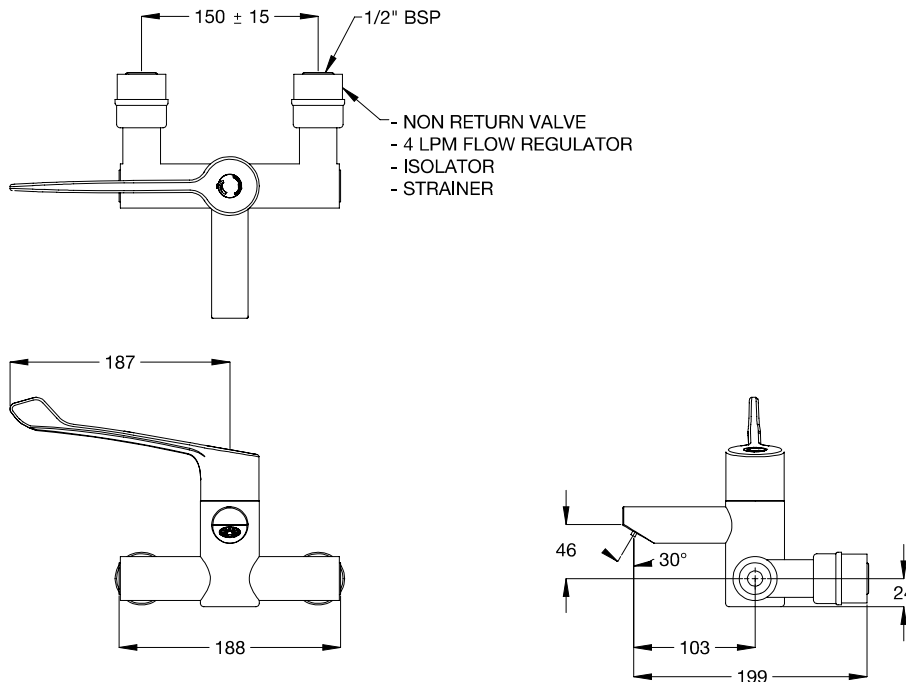

4.1 TECHNICAL DATA		
Inlet		½" BSP – Female
Outlet		Flow Straightener
Headwork		Thermostatic mixing valve
Working Pressure Range (kPa)	Min	20
	Max	500
Working Temperature Range (°C)	Min	5
	Max	85
Finish		Chrome
NOTE: Galvin Specialised continually strive to improve their products. Specifications may change without notice.		

Table 1. Technical Information

5.0 WATER SUPPLY CONDITIONS

INTRODUCTION

This CliniMix® Lead Safe™ Wall Mounted Thermostatic Progressive Basin Mixer 135 – 165 is manufactured to the highest standards. When installed the supply conditions detailed below must be observed.

SUPPLY REQUIREMENTS

This mixer is designed to be installed on all types of plumbing systems.

Hot and cold water supply pressures should be reasonably balanced; however, the mixer will function within specification on unequal pressures up to 10:1.

The mixer has integral isolating valves which permit servicing of the strainer, check valve/flow regulator and thermostatic cartridge. They are also used for thermal disinfection.

The minimum pressure for the correct thermal operation is 20kPa. However, to achieve an acceptable flow performance at very low pressures it may be necessary to remove the combined check valve and flow regulators and replace them with simple check valves.

Hot Temperature Supply Range (°C)	Min	5
	Max	85
Minimum Temperature Differential (between the supply and the outlet temperature) (°C)		10
Adjustable Temperature Range	Min	35
	Max	48
Maximum Static Pressure (kPa)		1000
Working Pressure Range (kPa)	Min	20
	Max	500*
Permitted Supply Pressure Variation		10:1
Factory Set Thermostatic Temp. (°C)		41
Maximum Thermostatic Temperature (°C)		48
Minimum Flow Rate for Stable Outlet Temperature (LPM)		6
Nominal Flow Rate (LPM)		8

Table 2. Water supply conditions

*Tapware must be installed in accordance with the provisions of AS/NZS 3500. Installations not complying with AS/NZS 3500 may void the product and performance warranty provisions.

6.0 INSTALLATION

The CliniMix® Thermostatic Progressive Mixing Valves must be installed using the appropriate Standard, Code of Practice and legislation application to each state and following the details outlined in this section.

The CliniMix® Thermostatic Progressive Mixing Valves must be installed by a licensed plumber, or where applicable, a licensed plumber who has undertaken T.A.F.E. training in Thermostatic Mixing Valves.

Note: To effectively control microbial hazards during system design, installation, commissioning and maintenance, the requirements outlined in AS/NZ3666 and local legislation shall be adhered to.

If the valve is not installed correctly then it will not function correctly and may put the user in danger. It may also void the warranty of the valve.

Prior to the installation of the valve, the system must be checked to ensure that the system operating conditions fall within the recommended operating range of CliniMix® Progressive Thermostatic Mixing Valve. If the hot water supply temperature is greater than 90° Celsius, the valve may be damaged. If the temperature of the hot water will rise above 90° Celsius a suitable temperature limiting valve must be fitted to the hot water supply, prior to the inlet fittings. This temperature limiting valve must be installed as per the manufacturer’s instructions. It is important that both inlet dynamic supply pressures are 500kPa or less. If either supply pressure exceeds 500kPa then a suitable pressure reducing valve must be fitted prior to the inlet control valve to reduce the pressure to an acceptable limit.

These pressure reducing valves must be installed as per the manufacturer’s instructions. To achieve optimum performance from the valve it is recommended that the inlet pressures are balanced to within 10% of each other.

The water quality conditions should be checked to ensure they do not exceed the limits as listed in AS3500.4, Section 3.7.1. If they do exceed these limits, then it will be necessary to install a water softener or water treatment device.

INSTALLATION COMPLIANCE: Galvin Specialised products must be installed in accordance with these installation instructions and in accordance with AS/NZS 3500, the PCA and your local regulatory requirements. Water and/or electrical supply conditions must also comply to the applicable national and/or state standards. Failing to comply with these provisions shall void the product warranty and may affect the performance of the product.

6.1 MOUNTING DETAILS

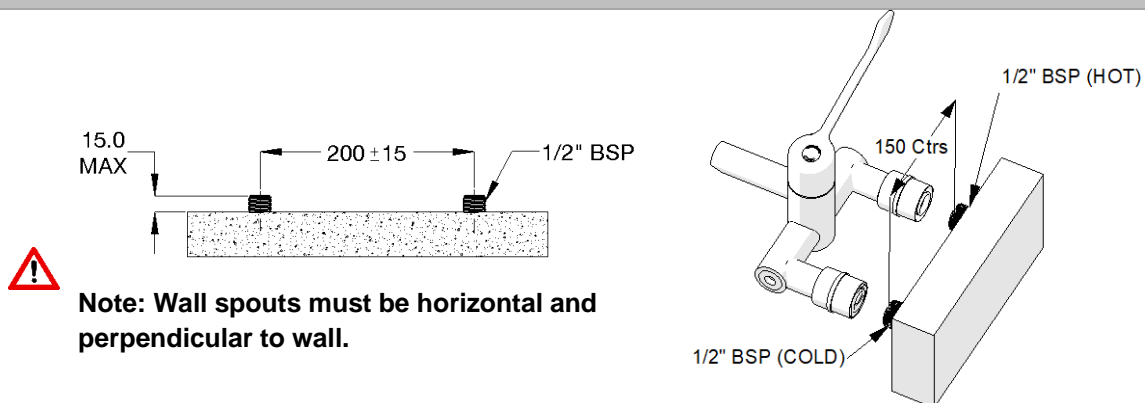

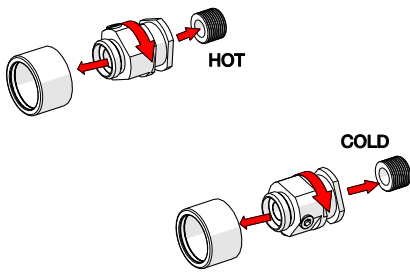

1. Fit isolator connector

- Ensure 1/2" male hot and cold water supply outlets are positioned as per mounting details at the desired height and location above the basin/sink.
- Separate both wall offset Isolator Connectors from assembly.
- Remove chromed sleeve from the connectors



Note: Hot supply should be on the left when facing the wall

- Apply thread tape to the male threaded outlets and fit the isolator connectors.

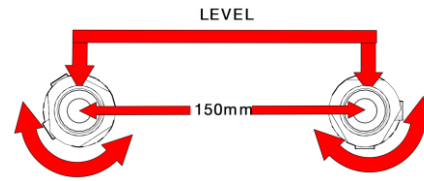

2. Adjust the connectors

- The isolator connectors are offset to provide +/- 15mm of rotational adjustment.
- With the use of a spirit level and tape measure, you are required to
 - Position the back of the bases within 3mm of the finished wall and;
 - Ensure the bases are level and;
 - Achieve 200mm centre to centre of the connectors

Note: The use of thread tape is recommended to ensure bases stay in the required position and are water tight.

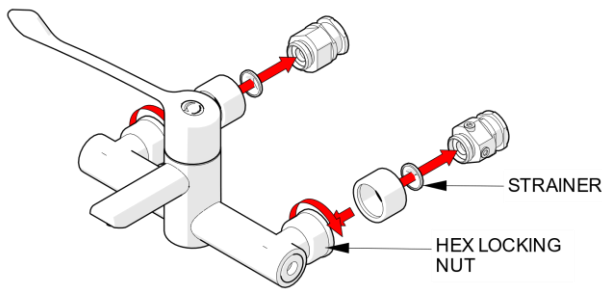

3. Fit progressive mixer

- Fit chrome sleeves to fitted isolator connectors.
- Tighten loose nuts on the body to the isolator connectors already on the wall ensuring the strainer seal is in between. Do not over tighten.

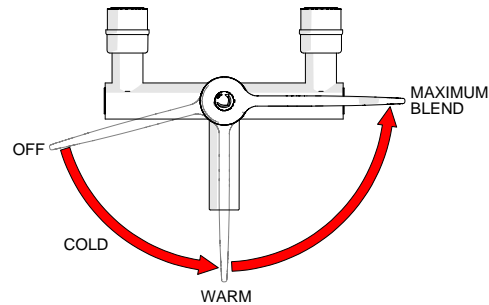

4. Testing and operation

- Ensure the handle is in an OPEN Position (see above for correct handle positions).
- Open both hot and cold side isolation valves. Turn on each water supply separately and check for leaks. If leaking, check sealing washer on wall connectors and repeat installation steps.
- Turn mixer on and test operation. Commission the unit as per section 7.0.

6.2 HANDLE POSITIONING

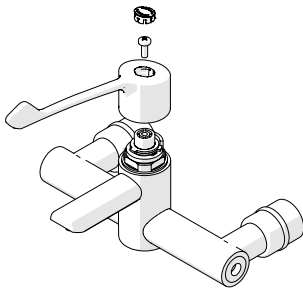

1. Fully open valve (anti-clockwise).
2. Remove the handle assembly. To prevent damage, carefully prise off plastic indicator from the handle. (Use a small flat bladed screwdriver if necessary). Use 4mm Hex key to remove holding screw.

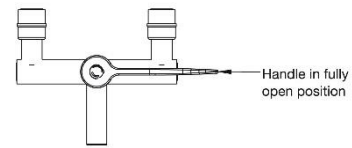

3. Refit handle onto spline as shown.

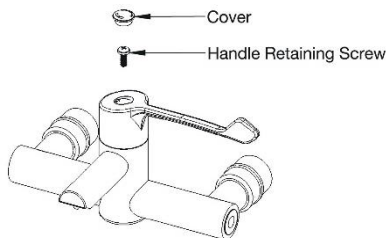

4. Fit handles screw & tighten with a 4mm Hex Key. Finally, fit cover cap to handle.

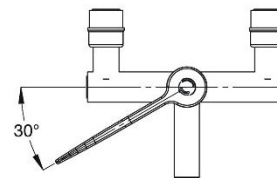

5. Rotate handle clockwise to closed position. Handle should stop in approximate position shown.

7.0 COMMISSIONING

Initial Test for Correct Operation

The following must be checked to ensure the correct performance of the progressive thermostatic mixer:

- the supply pressures and temperatures are within the range of operating pressures and temperatures for the thermostatic valve.
- the supply temperatures are within the range permitted for the unit.

Please record the testing done during the commissioning and record the temperature of the hot and cold-water supplies and the temperature of the mixed water at the full hot setting.

A calibrated digital thermometer having rapid response time with maximum temperature hold will be required to check and set the outlet mixed temperature of the mixer.

To Commission

To test the temperature, open the valve and allow the mixed heated water to flow for at least 30 to 60 seconds so the temperature can stabilise before taking a temperature reading at the outlet with a digital thermometer. The flow rate should be at least 4L/min.

The temperature should be taken close to the mixer's outlet and if the outlet temperature requires adjustment then follow the temperature adjustment in the installation instructions.

Shut Down Test

Once the correct outlet temperature has been achieved, the valves internal mechanism should be exercised at least 3 times by alternately shutting off the hot and cold supplies while the mixer is set in the full hot position.

Shut Down Test 1

With the mixer still set in the full hot position and with both supplies turned on, allow the mixed water temperature to stabilise for at least 15 seconds and note the outlet temperature. While holding a digital thermometer in the outlet flow, quickly isolate the cold water supply to the valve

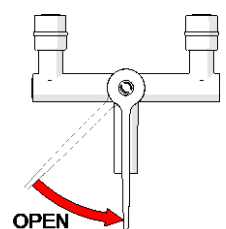

Handle in open position

The outlet flow should quickly reduce to be less than 0.1L/min following the isolation. Recording of the temperature should continue after isolation and should not exceed the maximum temperature set out in the applicable standard or code of practice for each state.

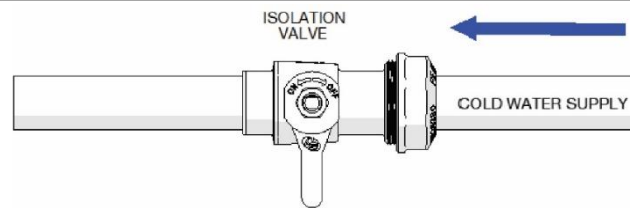

Restore the cold-water supply to the valve. After the mixed water temperature has stabilised note the outlet temperature ensuring the outlet temperature has re-established. The time taken to stabilise the temperature should not exceed the maximum time set out in the applicable standard or code of practice for each state.

Shut Down Test 2

With the mixer still set in full hot position and with both supplies turned on allow the flow to stabilise for at least 15 seconds and record the temperature. Quickly isolate the hot water supply to the valve.

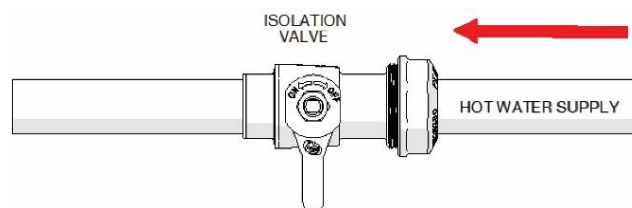

The outlet flow should quickly reduce to be less than 0.4L/min following the isolation. The volume of mixed water discharged for a period of between 5-35 seconds should be measured and should not exceed the maximum volume set out in the applicable standard or code of practice for each state.

Restore the hot water supply to the valve and measure and record the outlet temperature after the mixed water temperature has stabilised. The time taken to stabilise the temperature should not exceed the maximum time set out in the applicable standard or code of practice for each state.

Ensure that all details of the Commissioning Report are completed, and a copy is kept with the installer and owner of the premises.

The valve is now commissioned, and it can be used within the technical limits of operation.

NOTE: In some installations, certain types of tapware devices such as flick mixers and solenoid valves are used. The water pressure may be seen to spike outside that recommended for the valve, during rapid shut off conditions with these types of devices. Even if the spike only lasts a split second it is still considered to be outside the operating conditions and may cause the valve to operate incorrectly. In the event that this does occur, measures must be taken to control the spike, such as the installation of an inline pressure reducing valve directly before the valve inlets.

To ensure that the mixing valve operates correctly, it is necessary that the pipe-work is thoroughly flushed with clean water before the valve is installed. This will remove any physical contaminants from the pipe-work, ensuring trouble-free operation. During the flushing procedure, care should be taken to prevent water damage occurring to the surrounding area.

It is a requirement of AS3500.4.2 that “Each thermostatic mixing valve shall have an isolating stop tap/valve, line strainer and non-return valve fitted to the hot and cold water supply lines”. The inlet fittings supplied with each TMV will ensure this requirement is met. If the CliniMix® Progressive Thermostatic Mixing Valve is to be installed without the supplied inlet control valves then it will be necessary to install a separate isolating valve, non-return valve and strainer to both inlets to the valve.

Strainers must be fitted to prevent any particulate contamination from entering the valve. These strainers should be 60 mesh stainless steel (0.250mm). Isolating valves are required so that the water supply to the valve can be isolated when servicing is required. Non-return devices must also be fitted to both the hot and cold inlets to prevent cross-contamination.

Ensure that the test plugs in the top of the inlet fittings are tight.

The valve should be installed so it can be easily accessed for maintenance or servicing.

During installation or servicing, heat must not be applied near the mixing valve or inlet fittings, as this will damage the valve and inlet fittings internals. Failure to comply with this requirement will damage the valve and fittings. It will put the user at risk and it will void the warranty of the valve.

Note: The CliniMix® Thermostatic Progressive Mixing Valve is intended mainly for use in applications with set temperatures below 45° Celsius. When installed at higher set temperature, the performance may be less than specified in AS4032.4. In such situations consideration should be given to the question of whether an alternative device, i.e. a tempering valve approved to AS4032.2 would provide a greater margin for safety in reducing scalding accidents.

8.0 OPERATION

As the handle is rotated anti-clockwise from the off position the delivered water progresses from cold through warm to the pre-set maximum temperature of approximately 41°C

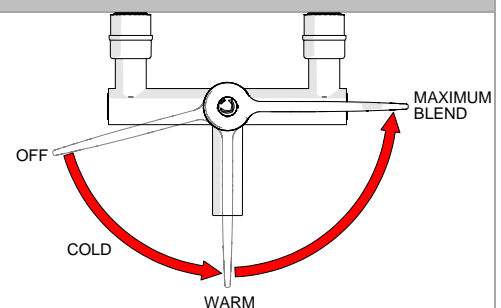

9.0 SERVICING

The need for servicing is normally identified as a result of the regular performance testing.

Application	Maximum mixed water temperature during normal operation	Permitted maximum temperature rise recorded during site testing
Washbasin	41°C	45°C

Table 3. A guide to maximum temperature sets. Please refer to AS3500 for temperature settings

9.1 Frequency of Regular Servicing

The purpose of servicing regularly is to monitor any changes in performance due to changes in either the system or the product. This may highlight the need to adjust either the supply system or the product. These products should be checked at 6 to 8 weeks and again at 12 to 15 weeks after commissioning. The results are to be compared against original commissioning settings.

If there are no significant changes at the mixed temperature outlet then a 6 monthly servicing cycle may be adopted.

Otherwise, servicing checks should be carried out more frequently (e.g. every 4 months).

Follow the recommended maintenance procedures detailed in section 10.

During servicing, note the following:

1. Repeat the procedure of recording and checking supply temperatures. (The same type of measuring equipment should be used)
2. If the temperature has changed significantly from the previously recorded valves, the following should be checked:
 - a. All in-line or integral valve filters are clear of obstruction.
 - b. All in-line or integral check valves are clean and working properly to prevent backflow.
 - c. Any isolating valves are fully open.
 - d. The thermostat is free of debris
3. When satisfied with the mixed outlet temperatures re-record the temperatures.

9.2 General Servicing

General Servicing of the CliniMix® Lead Safe™ Wall Mounted Thermostatic Progressive Basin Mixer 135 – 165

Prior to servicing the mixer, turn off both the hot and cold water supply.

- Ensure both the hot and cold water supplies have been isolated. Open the mixer to ensure water supplies have been isolated correctly and no water flows.

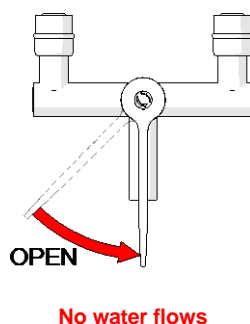

Servicing - Strainer and Non-Return Valves

- Ensure both the hot and cold water supplies have been isolated.
- Slide the cover sleeves forward (to the body).
- Unscrew the brass union using metric spanner 30mm. Remove strainers then using circlip pliers, remove clips from both fittings. Remove the non-return valves.
- The strainers and non-return valves should be cleaned with a dilute water solution of suitable de-scaling solvent (such as CLR), checked for physical damage and then thoroughly rinsed with clean water.
- Replace any broken filters or faulty non-return valves.

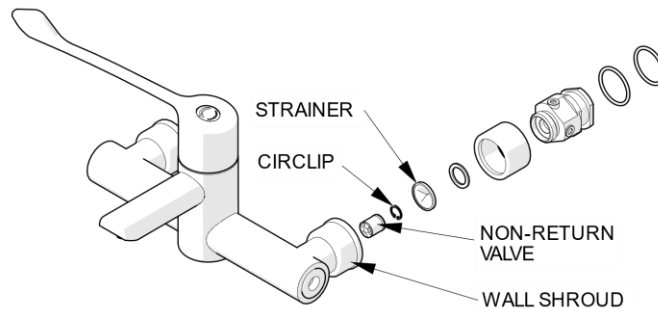

Removal and inspection of cartridge

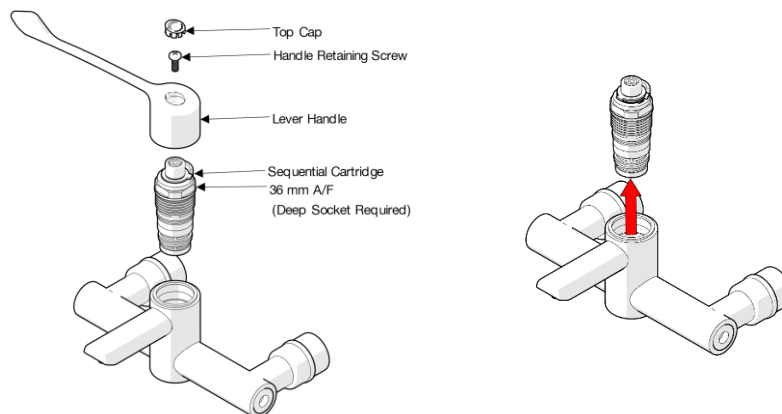

1. After checking that supply conditions are within the specified parameters (see table 1), if the fitting malfunctions or should the test results fail to fall within the specified limits consider replacing the cartridge with a new one. See 10.2 Important notes on debris.
2. Refer to section 11.0 for the full isolation procedure.
3. Isolate the fitting by turning the isolating valves 90° anti-clockwise (viewed facing the isolation valve).
4. Remove the lever handle. Unscrew the cartridge from the body with a 36mm AF deep socket. Clean all components thoroughly and inspect cartridge for damage. If the components are damaged, the cartridge must be replaced.
5. The cleaned cartridge (or a new cartridge, if this is required) can now be re-installed, by screwing into the mixer body until it reaches a firm stop and tightened.
6. The cartridge should be tightened to a torque of 15Nm.
7. Replace lever handle (see section 6.2) and reinstate the water supplies.
8. After fitting the new cartridge, perform the commissioning procedure (section 7.0).

When service is complete, slowly open the cold water isolation valve and inspect mixer body for leaks. Repeat with hot water isolation valves. Open the mixer by rotating handle anti-clockwise and check operation and flow. Commence commissioning process.

Annual Maintenance Procedure

- Every 12 months the thermostatic mixer must be inspected & tested. The valve should be inspected for leaks or water damage and appropriate action taken if required.
- Carry out the general servicing of the valve as set out in this document
- A thermal shut down test is performed (Shut Down Test 1 and 2 as set out in this document), and the temperature is reset as required.
- If the valve fails to shut down or fails to maintain its set temperature, then refer to Troubleshooting section.

5 Year Maintenance Procedure

- Every five years the thermostatic mixer needs to have a full service carried out. This service consists of the same procedure as the 'Annual Maintenance Procedure' listed plus the thermostatic mixer cartridge must be replaced.
- After replacing the thermostatic mixer cartridge, a thermal shut down test is performed, and the temperature re-set as required. If the valve fails to shut down or fails to maintain its set temperature, then refer to the troubleshooting section.
- Once the 5 yearly maintenance procedure is complete, the thermostatic mixer should then be commissioned as per instructions.

10.0 MAINTENANCE

When installed as an AS/NZS 4032.4 application it is a requirement that the commissioning (section 7) and maintenance procedures (section 10) are carried out before use.

10.1 Adjustment of the mix temperature

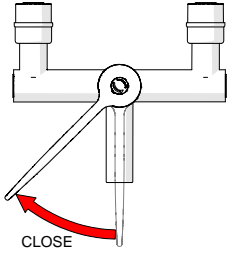
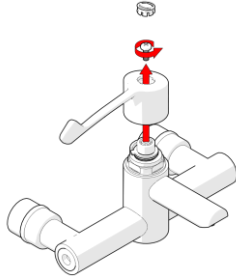
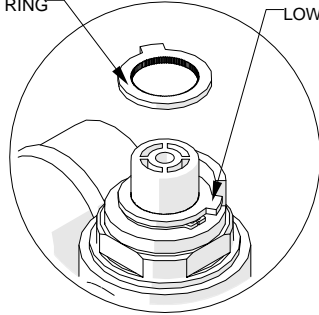
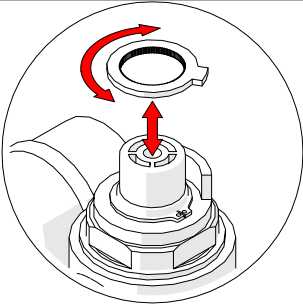
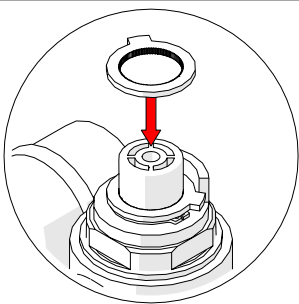
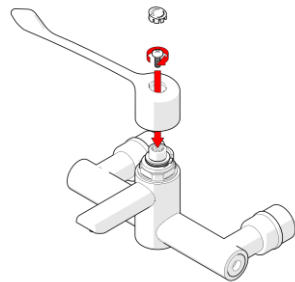
 <p>1. Close the valve.</p>	 <p>2. Remove top cap, screw and handle, ensure that the cartridge is closed.</p>	 <p>3. Remove the upper brass ring (closure setting ring). Make sure the control rod doesn't rotate.</p>
 <p>4. Remove the lower brass ring (temperature setting ring) and rotate the brass ring clockwise to increase temperature or anti-clockwise to decrease.</p>	 <p>5. Reposition the upper ring in the same position – up against the stop.</p>	 <p>6. Test the set temperature. If the temperature is acceptable, reposition the handle (section 6.1), the screw and the top cap otherwise repeat from step 3 to 6.</p>

10.2 Important notes on debris

Although this product is protected by built-in filters, debris can still find its way to the thermostat housing area. This can happen during servicing for example. Remove cartridge (see section 10.2) and carry out an inspection.

10.3 Maintenance cleaning

On a regular basis the anti-splash nozzle should be inspected and cleaned if necessary. This should be done immediately before sterilising is carried out.

In areas where lime scale build-up is prevalent this will have to be removed. An inhibited proprietary scale solvent can be used such a kettle descaling solvent, but it is important to follow the manufacturer's guidelines. After descaling it is important to rinse the parts thoroughly in clean water. Clean carefully and do not use abrasive materials or scrapers.

11.0 DISINFECTION

This fitting is equipped with a disinfecting feature, which allows an engineer to feed water from the hot inlet via a temporary by-pass hose* into the cold inlet. This hot water then passes through the cold inlet, the thermostatic mixing chamber and out through the mixed water outlet. The temporary bypass hose is inserted into special valve connectors in the inlet tails normally concealed by the shrouds.

Safety Note: Care should be taken when carrying out the following procedure to avoid contact with hot water and hot surfaces. We recommend the use of protective hand wear.

To disinfect the fitting proceed as follows:

1. Slide forward the wall shrouds.
2. Isolate both inlets by turning the isolation valves through 90° anti-clockwise (see picture 1 below).
3. Unscrew the two plugs (see picture 2 below) and fit the two G 3/8" x G 1/8" fittings from the Disinfection kit (WM-PMDK). Fit the supplied flexi-hose between these fittings (see pictures 3 and 4 below).
4. Now turn the hot isolation valve clockwise (see picture 5 below).
5. Turn on the mixer. Hot water will now pass from the hot inlet, through the by-pass hose into the cold inlet and into the thermostatic mixing chamber and spout.
6. Once the desired disinfection time is complete, isolate the hot water supply (see picture 5 below).
7. Remove hose and nipples and refit plugs (see pictures 6, 7 and 8 below). Turn on water supply (see picture 9 below) and reset sensor for correct operation.



Warning: hose will be hot after disinfection process, remove with caution.

* Disinfection hose kit (WM-PMDK) is not supplied with this tap but can be purchased separately. See Galvin Engineering for details.

See Table 3 below for a guide to disinfection temperatures v/s time:

Temperature	Disinfection Time
60 degrees Celsius	30 Minutes
65 degrees Celsius	15 Minutes
70 degrees Celsius	10 Minutes

Table 3

<p>1.</p> <p>Shut off valves: Turn screws to close, both hot and cold</p>	<p>2.</p> <p>Unscrew and remove both plugs</p>	<p>3.</p> <p>Screw both fittings in</p>	<p>4.</p> <p>Screw the flexible hoses on to the fittings</p>	<p>5.</p> <p>- Open ONLY the hot water shut off valve so table for times At end of process close the hot shut off valve</p>
<p>6.</p> <p>Remove flexible hose</p>	<p>7.</p> <p>Unscrew both fittings</p>	<p>8.</p> <p>Screw in both plugs</p>	<p>9.</p> <p>Open both shut-off valves</p>	

12.0 WARRANTY

The Galvin Engineering CliniMix Thermostatic Progressive Mixing Valves is guaranteed free from manufacturing faults for a period of 12 months, subject to the condition outlines below;

GALVIN ENGINEERING PRODUCT WARRANTY

Subject to the warranty conditions and exclusions set out below, Galvin Engineering products are warranted to be free from defects in materials and/or workmanship for a period of 12 months service life, and if found by Galvin Engineering to be so defective will be replaced as set out below. If the product is sold by a party other than Galvin Engineering, then it is sold by the seller as principal and the seller has no authority from Galvin Engineering to give any additional warranty on behalf of Galvin Engineering.

The benefits of this warranty are in addition to all other rights and remedies which the purchaser may have under the Trade Practices Act or similar laws of each State and Territory in Australia.

Warranty Conditions and Exclusions

Conditions:

1. The TMV must have been installed by a licensed plumber in accordance with the Galvin Engineering Installation Instructions and Application Guidelines supplied with the valve, and in accordance with the National Plumbing and Drainage Code AS3500 (the Code) current at the date of installation and all relevant statutory and local requirements in the State or Territory in which the product is installed.
2. Where the product is installed outside the boundaries of a metropolitan area as defined by Galvin Engineering, the cost of transport insurance and travelling shall be the purchaser's responsibility.
3. Where the valve comprises part of a hot water system, installation of that system must be in accordance with its manufacturer's recommendation, the Code and all relevant statutory and local State or Territory requirements.
4. The valve must be returned to Galvin Engineering together with a fully and correctly completed Galvin Engineering Warranty Claim Form.
5. Where the valve is replaced under warranty the replacement valve carries a new warranty as detailed herein.

Exclusions:

Replacement work will be carried out as set out in the Galvin Engineering Warranty above, but the following exclusions may cause the warranty to become void, and may incur a service charge including cost of parts where:

1. Damage has been caused by accident, Acts of God, misuse, incorrect installation, incorrect installation of the water supply system of which the product forms a part or attempts to disassemble the valve.
2. It is found that there is nothing wrong with the product
3. The failure of the valve is due in part or in whole to faulty manufacture/installation of the hot water supply system of which the product forms part.
4. The valve has failed directly or indirectly as a result of excessive water pressure or temperature outside the Supply Pressure Requirements, or corrosive environment.
5. The valve has failed due to foreign matter either from installation or the water supply.
6. The failure of the valve is due to scale formation in the waterways of the valve.
7. The failure of the valve is due in part, or in whole, to installation not in conformance with the requirements of the Code.
8. Galvin Engineering reserves the right to change its specifications without prior notice and will not accept liability for any claim arising from such change.
9. Subject to any statutory provisions to the contrary, claims for damage to furniture, carpets, walls, foundations or any other consequential loss either directly or indirectly due to leakage from the valve are also excluded from warranty cover.

13.0 TROUBLESHOOTING

PROBLEM	CAUSE	RECTIFICATION
The desired mixed water temperature cannot be obtained, or valve is difficult to set.	<ul style="list-style-type: none"> Hot and cold supplies are fitted to the wrong connections Thermostatic cartridge contains debris or is damaged Strainers contain debris Non-return devices are damaged 	<ul style="list-style-type: none"> Refit the valve with Hot/Cold supplies fitted to the correct connections Clean the Cartridge ensuring that all debris is removed, and components are not damaged. Replace if necessary Clean strainers ensuring debris is removed Check non-return device is not jammed. Clean it if necessary Check for airlocks in the water supply
When the water is set at cold, the blended temperature is too hot	<ul style="list-style-type: none"> Hot & Cold water supply connections are installed in reverse. 	<ul style="list-style-type: none"> Refit the valve with Hot/Cold supplies fitted to the correct connections
The thermostatic mixing valve will not shut down	<ul style="list-style-type: none"> The hot to mix temperature differential is not 10°C or greater Thermostatic cartridge contains debris or is damaged Non-return devices are damaged 	<ul style="list-style-type: none"> Raise hot water temperature Clean the cartridge ensuring that all debris is not jammed. Clean if necessary
Mix temperature unstable	<ul style="list-style-type: none"> Flow rate below 2L/min Thermostatic cartridge contains debris or is damaged Strainers contain debris Non-return devices are damaged 	<ul style="list-style-type: none"> Rectify any pressure deterioration Clean the cartridge ensuring that all debris is removed and components are not damaged. Replace if necessary Clean strainers ensuring debris is removed Check non-return device is not jammed. Clean if necessary
Mix temperature changing over time	<ul style="list-style-type: none"> Inlet conditions (pressure or temperatures) are fluctuating Strainers contain debris 	<ul style="list-style-type: none"> Install suitable pressure control valves to ensure inlet conditions Clean strainers ensuring debris is removed
Either full hot or cold flowing from outlet fixture	<ul style="list-style-type: none"> The upper temperature ring is incorrectly set Hot/Cold water has migrated to another inlet No flow from Hot and Cold supplies – damaged check valves Refer also to fault/symptom 1 & 2 	<ul style="list-style-type: none"> Re-set temperature to between 35-46°C as required Replace faulty check valves
Water is not flowing from outlet	<ul style="list-style-type: none"> Hot or cold water failure Thermostatic cartridge contains debris or damage Strainers contain debris 	<ul style="list-style-type: none"> Remove aerator and clean then reinstall Restore inlet supplies and check mix temperature Clean the cartridge ensuring that all debris is removed and components are not damaged. Replace if necessary Clean strainers

14.0 APPENDIX

THERMOSTATIC PROGRESSIVE MIXING VALVE COMMISSIONING AND/OR MAINTENANCE

Note: In all cases the Licensee is to submit this report within seven working days after commissioning and/or servicing the valve.

1. Use a separate form for each valve.
2. The original report is to be given to the owner/occupier and retained on site for a minimum of 7 years.
3. All details are to be filled in. Incomplete reports will not be accepted.

PRINT ALL DETAILS or MARK WITH AN X IN BOXES TO INDICATE CHOICE

Name of Facility					
Street Address					
Suburb		State		Post Code	
Phone #		Contact Name			
Date		Work Order #			
Make & Model of Hot Water Unit					
Make of Mixing Valve			Model No		
			Size		
Valve ID No.			Total No. of Mixing Valves on Site/Building		
Valve Location / Building					
Area serviced by value					
Outlet type (mark with X)	Basin <input type="checkbox"/>	Shower <input type="checkbox"/>	Bath <input type="checkbox"/>		
Valve installed to requirements of:					
1. The local water supply Authority		2. The valve manufacturer / supplier requirements		3. The Australian Standards for Plumbing and Drainage	

<input type="checkbox"/> YES	<input type="checkbox"/> NO	<input type="checkbox"/> YES	<input type="checkbox"/> NO	<input type="checkbox"/> YES	<input type="checkbox"/> NO										
If NO, give details and action taken:															
Hot Water	Pressure (kPa)		Cold Water	Pressure (kPa)											
	Temp (°C)			Temp (°C)											
Cold Water Supply via	Pressure Reducing Valve Fitted			YES/NO											
Details of work carried out: <table style="width: 100%; border: none;"> <tr> <td style="width: 50%; border: none;"><input type="checkbox"/> Serviced</td> <td style="width: 50%; border: none;"><input type="checkbox"/> Visually inspected & clean valve</td> </tr> <tr> <td style="border: none;"><input type="checkbox"/> Commissioned</td> <td style="border: none;"><input type="checkbox"/> Checked function of NRV Components</td> </tr> <tr> <td style="border: none;"><input type="checkbox"/> Dismantle</td> <td style="border: none;"><input type="checkbox"/> Visually inspected & clean valve</td> </tr> <tr> <td style="border: none;"><input type="checkbox"/> Reassemble</td> <td style="border: none;"><input type="checkbox"/> Replaced o-rings and lubricate</td> </tr> <tr> <td style="border: none;"><input type="checkbox"/> Set temperature</td> <td style="border: none;"><input type="checkbox"/> Thermal shut down test</td> </tr> </table>						<input type="checkbox"/> Serviced	<input type="checkbox"/> Visually inspected & clean valve	<input type="checkbox"/> Commissioned	<input type="checkbox"/> Checked function of NRV Components	<input type="checkbox"/> Dismantle	<input type="checkbox"/> Visually inspected & clean valve	<input type="checkbox"/> Reassemble	<input type="checkbox"/> Replaced o-rings and lubricate	<input type="checkbox"/> Set temperature	<input type="checkbox"/> Thermal shut down test
<input type="checkbox"/> Serviced	<input type="checkbox"/> Visually inspected & clean valve														
<input type="checkbox"/> Commissioned	<input type="checkbox"/> Checked function of NRV Components														
<input type="checkbox"/> Dismantle	<input type="checkbox"/> Visually inspected & clean valve														
<input type="checkbox"/> Reassemble	<input type="checkbox"/> Replaced o-rings and lubricate														
<input type="checkbox"/> Set temperature	<input type="checkbox"/> Thermal shut down test														
List of items replaced and part numbers during this visit:		Service Kit No.													
		Other Parts													
Temperature range of warm water at outlet:															
<input type="checkbox"/> Neonatal and children 38-40°C <input type="checkbox"/> Adult 40.5-43.5°C <input type="checkbox"/> Set Temperature (°C):															
Date at this service/commissioning:			Date of next service due:												
Previous service carried out by:			Date of previous service:												
Valve installed by:			Date of installation:												
It is hereby certified that all the commissioning work has been carried out by the undersigned in accordance with local plumbing requirements for Thermostatic Mixing Valves.															
Contractor Business Name															
Contractor Name (print)		Contractor Lic/Cert No													
Signature Licensed Plumber															
Contractors Phone No:		Date													
Owner/Occupier Signature		Date													